

ONE RIVERPOINT

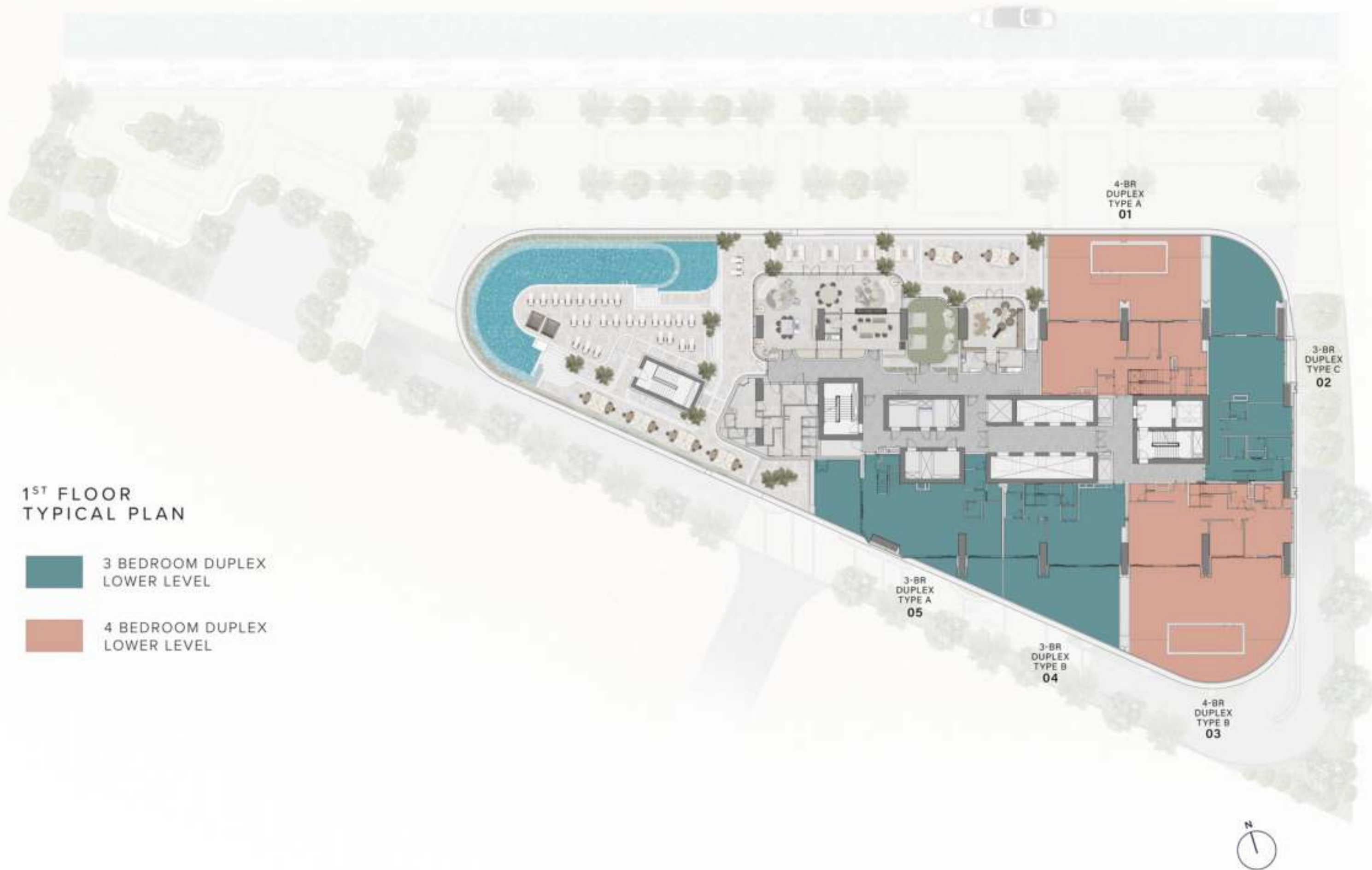

FLOOR PLAN

ONE RIVERPOINT



ONE RIVERPOINT



2ND FLOOR TYPICAL PLAN

-  3 BEDROOM DUPLEX
UPPER LEVEL
-  4 BEDROOM DUPLEX
UPPER LEVEL

ONE RIVERPOINT

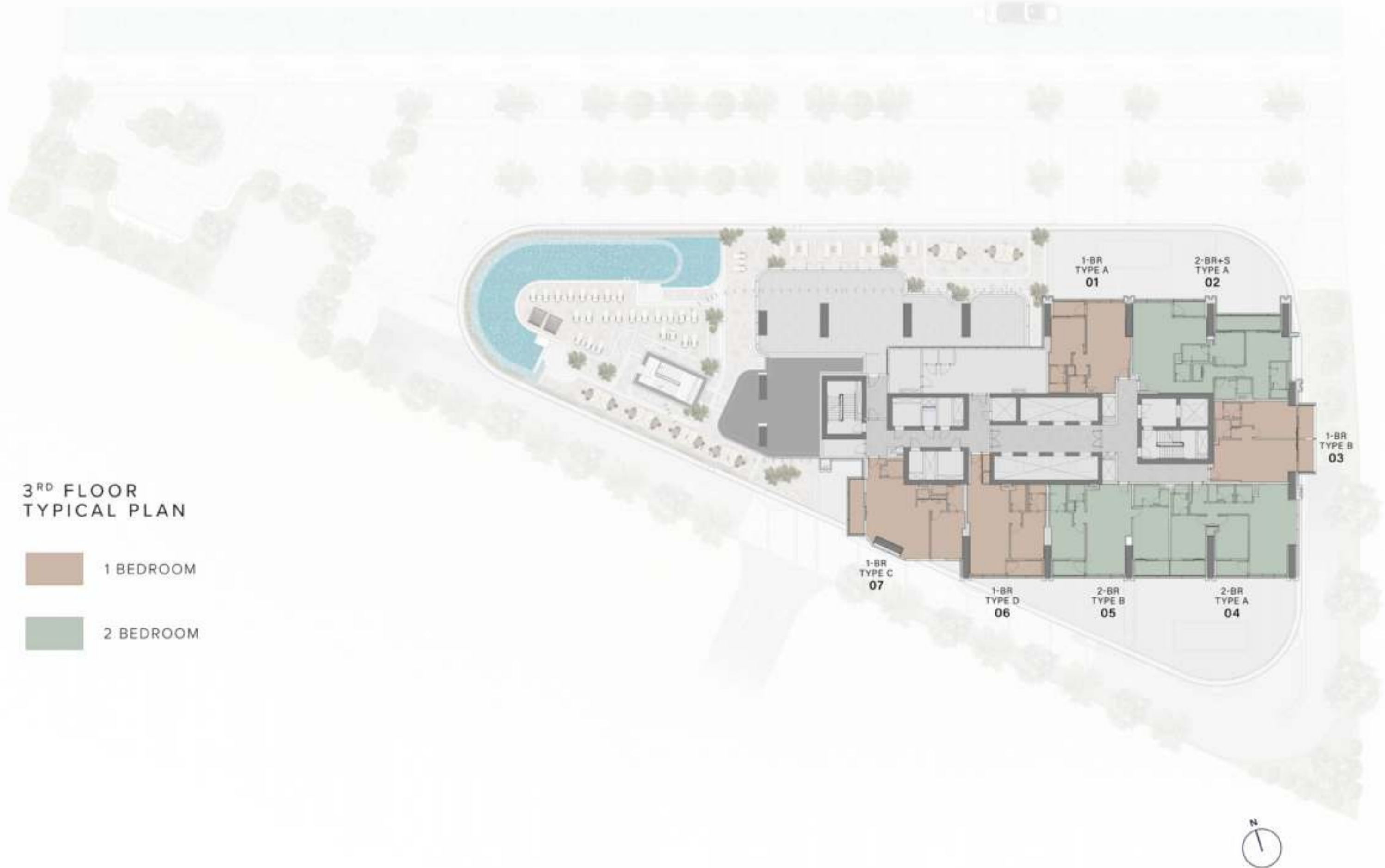

3RD FLOOR
TYPICAL PLAN

-  1 BEDROOM
-  2 BEDROOM

ONE RIVERPOINT

4TH FLOOR TYPICAL PLAN

-  1 BEDROOM
-  2 BEDROOM



ONE RIVERPOINT

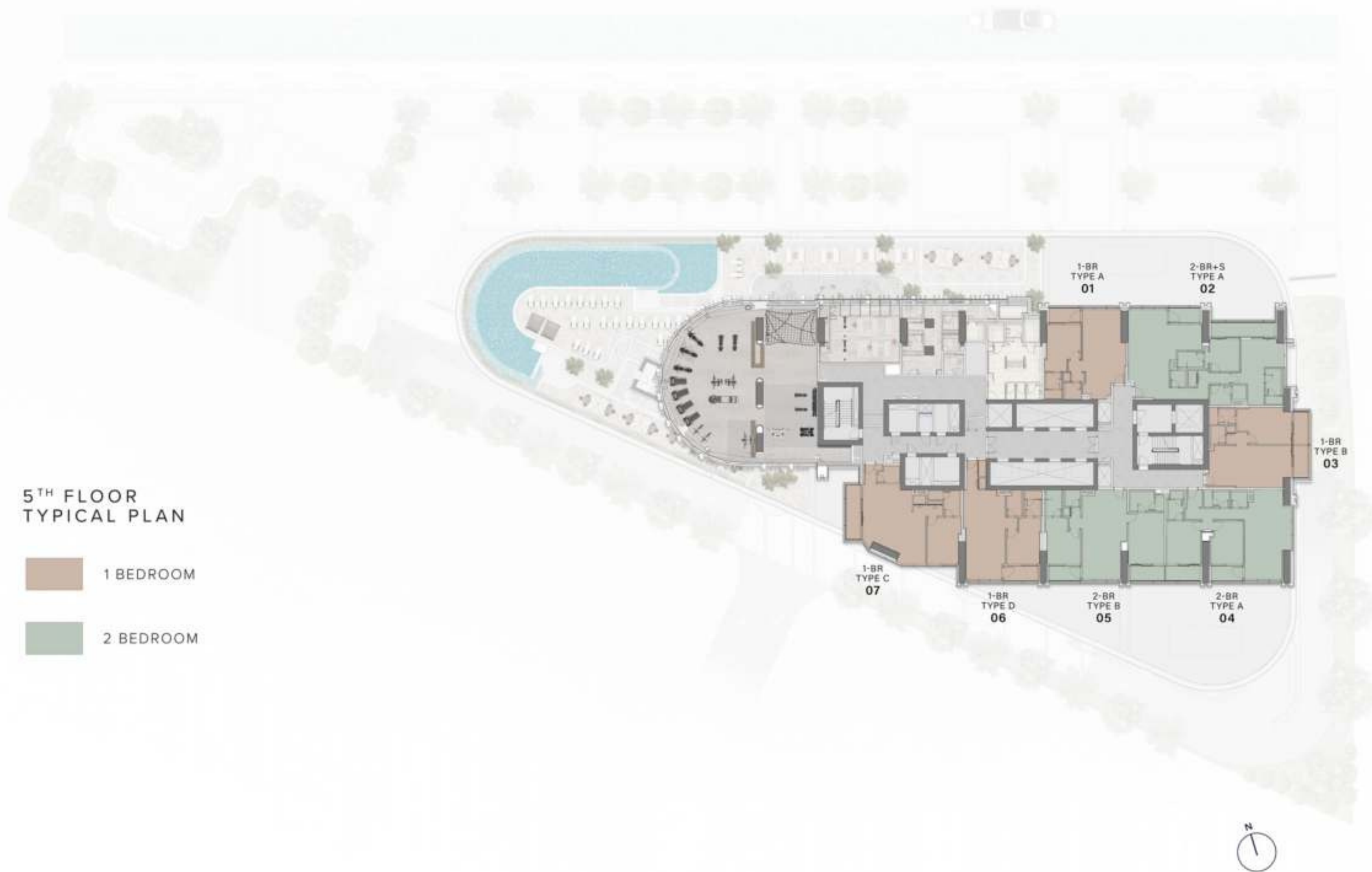

ONE RIVERPOINT

6TH FLOOR TYPICAL PLAN

-  1 BEDROOM
-  2 BEDROOM



ONE RIVERPOINT

7TH FLOOR TYPICAL PLAN

-  1 BEDROOM
-  2 BEDROOM



ONE RIVERPOINT

8TH - 16TH FLOOR TYPICAL PLAN

-  1 BEDROOM
-  2 BEDROOM
-  3 BEDROOM



ONE RIVERPOINT

18TH - 36TH FLOOR TYPICAL PLAN

-  STUDIO
-  1 BEDROOM
-  2 BEDROOM
-  3 BEDROOM



ONE RIVERPOINT

37TH FLOOR TYPICAL PLAN

-  3 BEDROOM
PENTHOUSE
-  4 BEDROOM
PENTHOUSE



STUDIO

TYPE A



Internal Living Area : **401.06 Sq.**
Outdoor Living Area : **Ft 86.43 Sq.**
Total Living Area : **Ft 487.50 Sq. Ft**

18th - 36th FLOOR

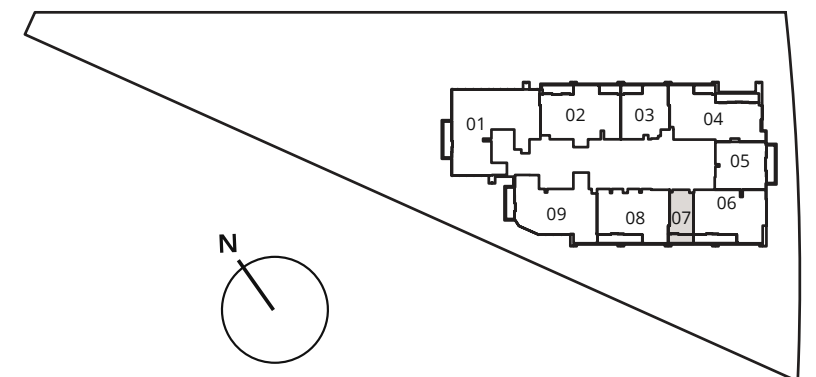

1 B E D R O O M

T Y P E A

Internal Living Area : **886.41 Sq. Ft**

Outdoor Living Area : **71.69 Sq. Ft**

Total Living Area : **958.10 Sq. Ft**



3rd FLOOR

301

4th FLOOR

401

5th FLOOR

501

6th FLOOR

601

7th FLOOR

701

8th - 16th FLOOR

803

18th - 36th FLOOR

1803

8th - 16th FLOOR

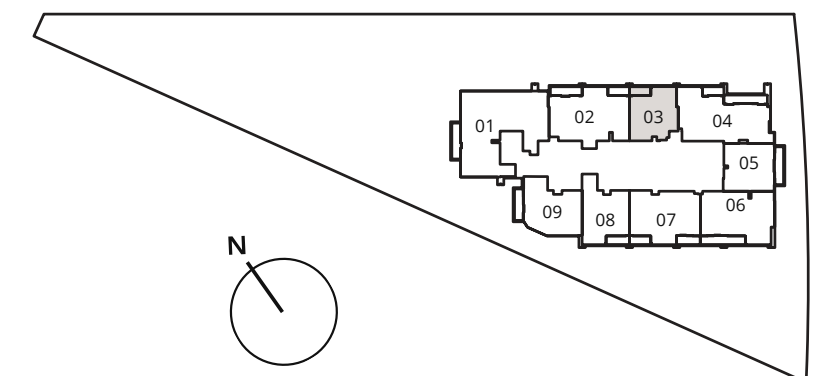

1 B E D R O O M

T Y P E B

Internal Living Area : **930.43 Sq. Ft**
Outdoor Living Area : **129.81 Sq. Ft**
Total Living Area : **1060.25 Sq. Ft**



3rd FLOOR

303

4th FLOOR

403

5th FLOOR

503

6th FLOOR

603

7th FLOOR

703

8th - 16th FLOOR

805

18th - 36th FLOOR

1805

8th - 16th FLOOR

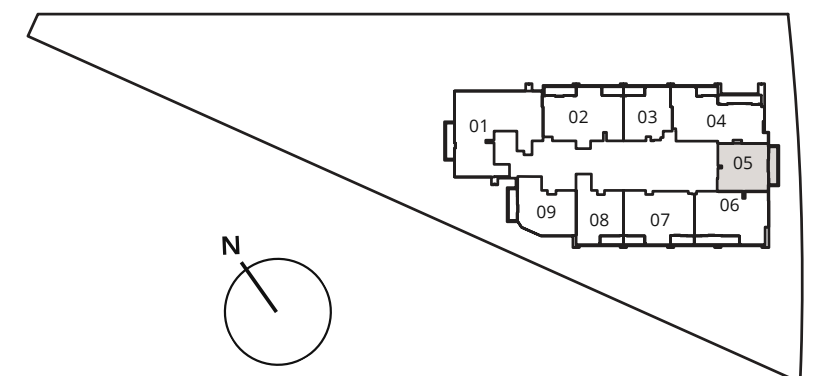

1 B E D R O O M

T Y P E C

Internal Living Area : **1090.49 Sq. Ft**
Outdoor Living Area : **107.10 Sq. Ft**
Total Living Area : **1197.59 Sq. Ft**



- | | |
|------------------------------------|--|
| 3rd FLOOR
307 | 7th FLOOR
707 |
| 4th FLOOR
407 | 8th - 16th FLOOR
809 |
| 5th FLOOR
507 | |
| 6th FLOOR
607 | |

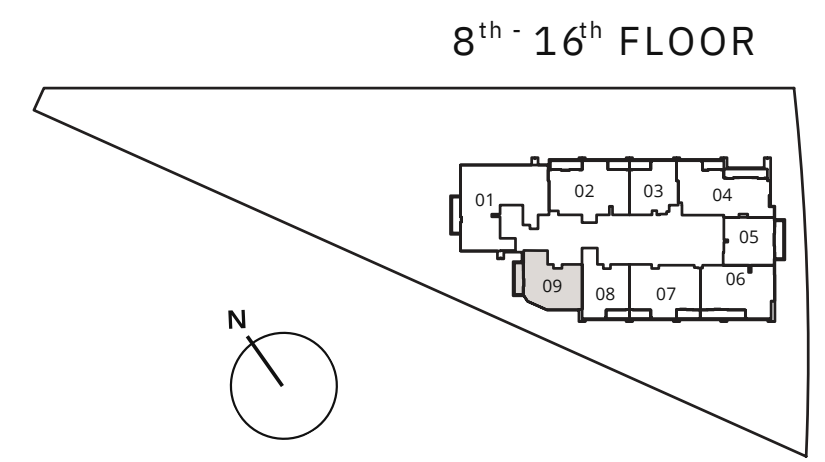

1 B E D R O O M

T Y P E D

Internal Living Area : **991.03 Sq. Ft**
Outdoor Living Area : **77.82 Sq. Ft**
Total Living Area : **1068.86 Sq. Ft**



3rd FLOOR

306

4th FLOOR

406

5th FLOOR

506

6th FLOOR

606

7th FLOOR

706

8th - 16th FLOOR

808

8th - 16th FLOOR

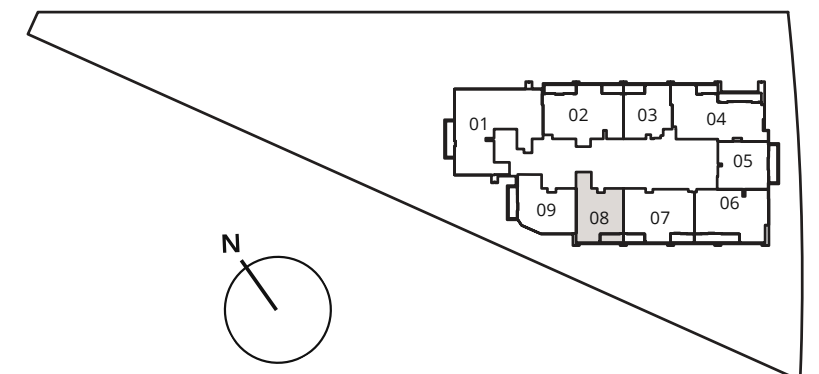

2 B E D R O O M

T Y P E A

Internal Living Area : **1337.31 Sq. Ft**

Outdoor Living Area : **152.63 Sq. Ft**

Total Living Area : **1489.94 Sq. Ft**



3rd FLOOR

304

7th FLOOR

704

4th FLOOR

404

8th - 16th FLOOR

806

5th FLOOR

504

18th - 36th FLOOR

1806

6th FLOOR

604

8th - 16th FLOOR

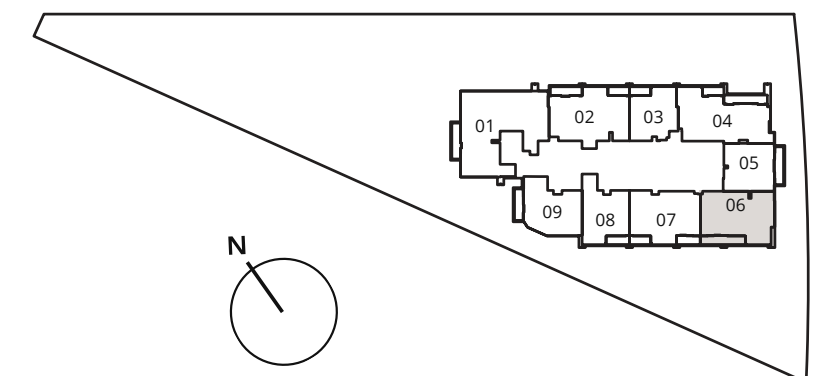

2 B E D R O O M

T Y P E B

Internal Living Area : **1295.22 Sq. Ft**
Outdoor Living Area : **152.63 Sq. Ft**
Total Living Area : **1447.85 Sq. Ft**

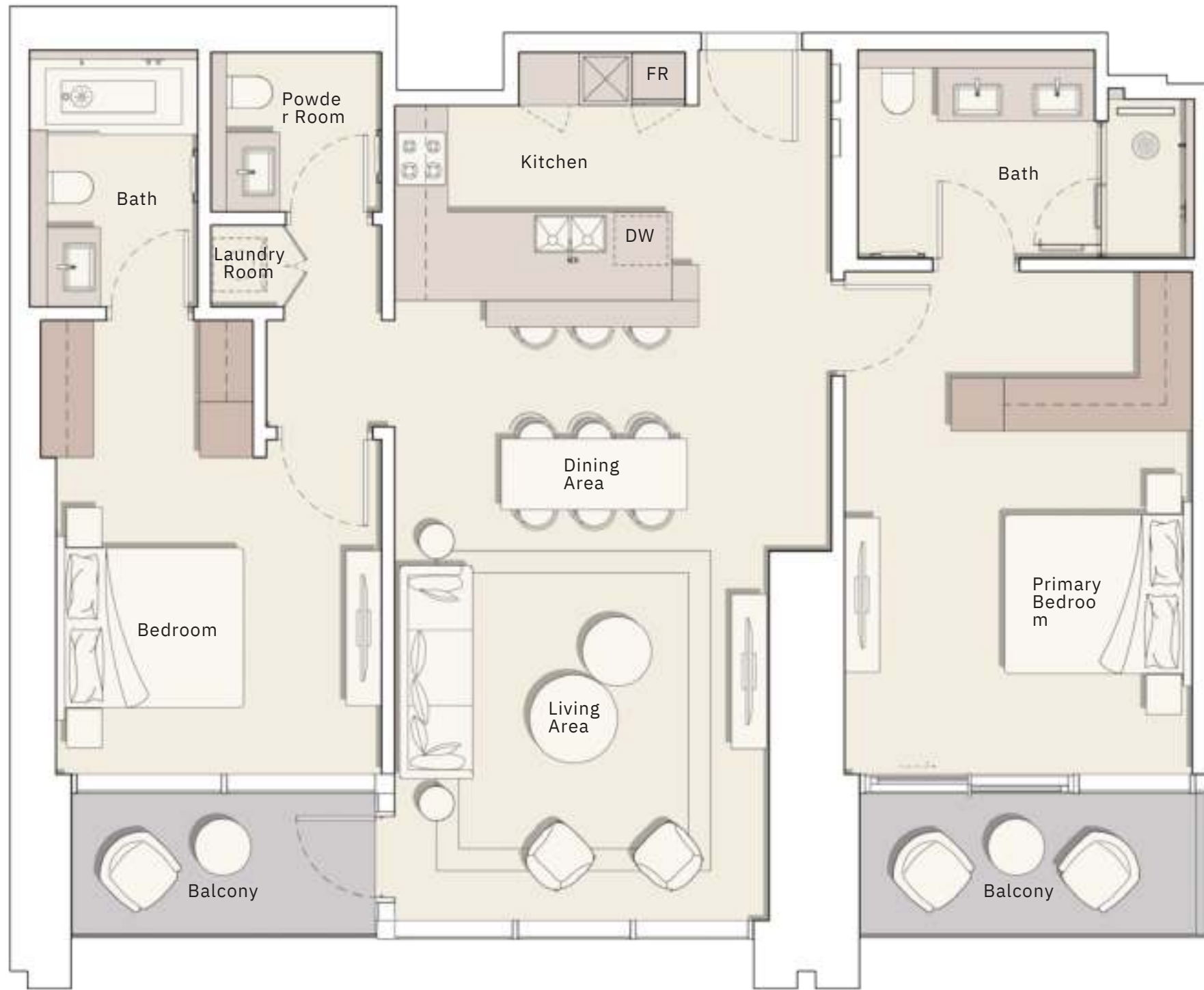

3rd FLOOR

305

7th FLOOR

705

4th FLOOR

405

8th - 16th FLOOR

807

5th FLOOR

505

6th FLOOR

605

8th - 16th FLOOR

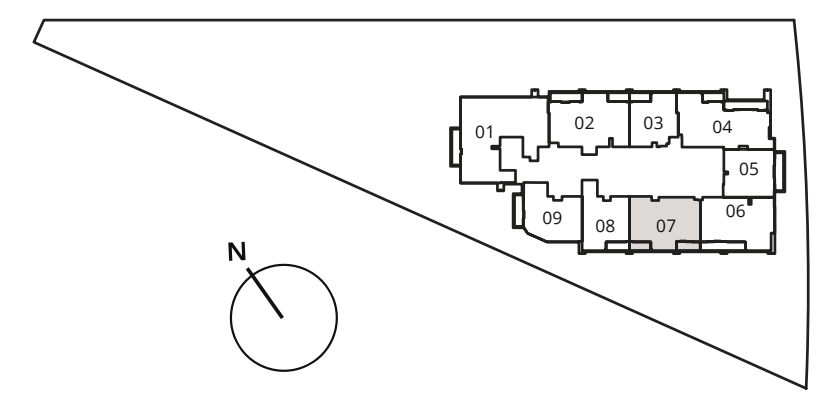

2 B E D R O O M

T Y P E C

Internal Living Area : **1328.48 Sq. Ft**
Outdoor Living Area : **151.77 Sq. Ft**
Total Living Area : **1480.25 Sq. Ft**



18th - 36th FLOOR

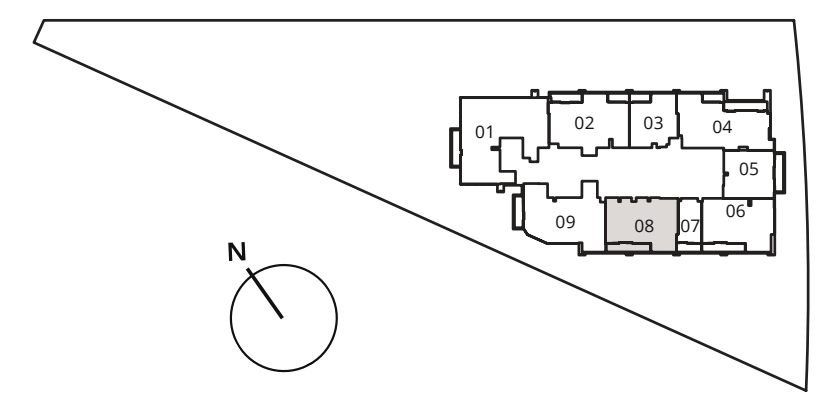

2 BEDROOM + S

TYPE A

Internal Living Area : **1573.04 Sq.**
 Outdoor Living Area : **Ft 222.92 Sq.**
 Total Living Area : **Ft 1795.96 Sq. Ft**



3rd FLOOR

302

4th FLOOR

402

5th FLOOR

502

6th FLOOR

602

7th FLOOR

702

8th - 16th FLOOR

804

18th - 36th FLOOR

1804

8th - 16th FLOOR

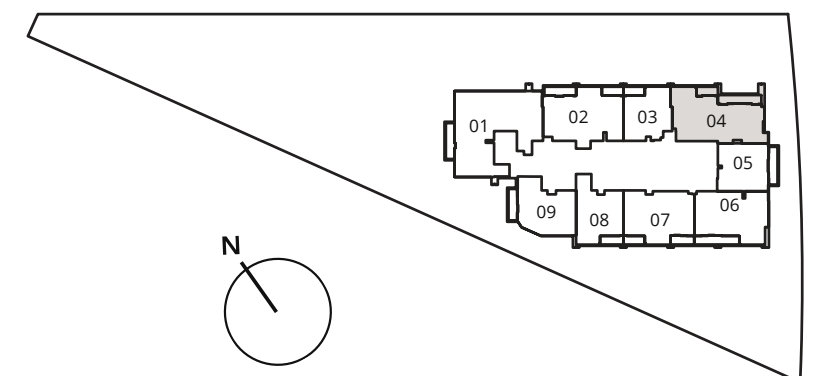

2 B E D R O O M + S

T Y P E B

Internal Living Area : **1509.53 Sq. Ft**

Outdoor Living Area : **178.79 Sq. Ft**

Total Living Area : **1688.32 Sq. Ft**

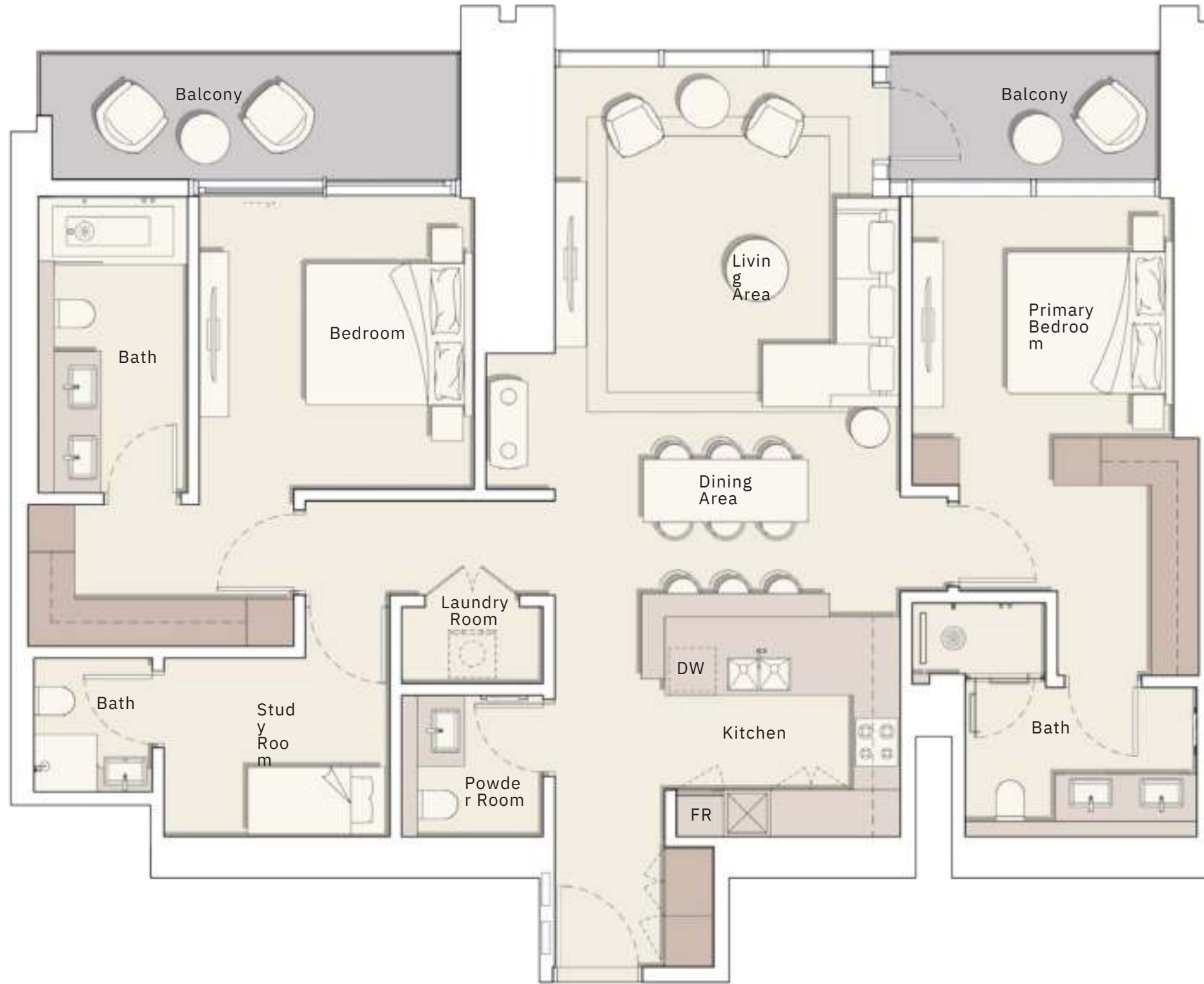

8th - 16th FLOOR

802

18th - 36th FLOOR

1802

8th - 16th FLOOR

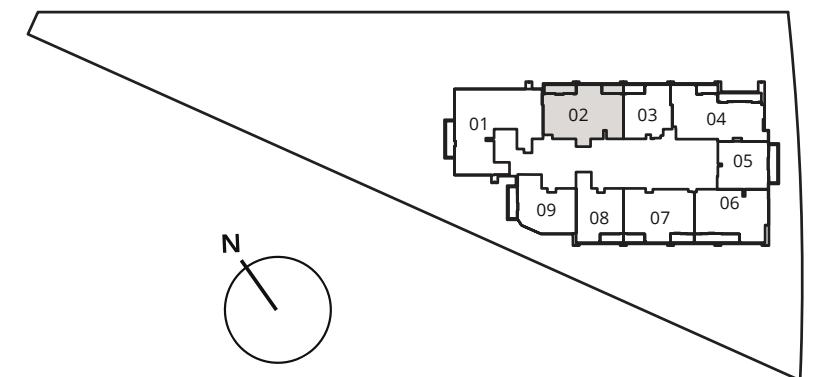

2 B E D R O O M + S

T Y P E C

Internal Living Area : **1678.20 Sq. Ft**

Outdoor Living Area : **107.10 Sq. Ft**

Total Living Area : **1785.30 Sq. Ft**

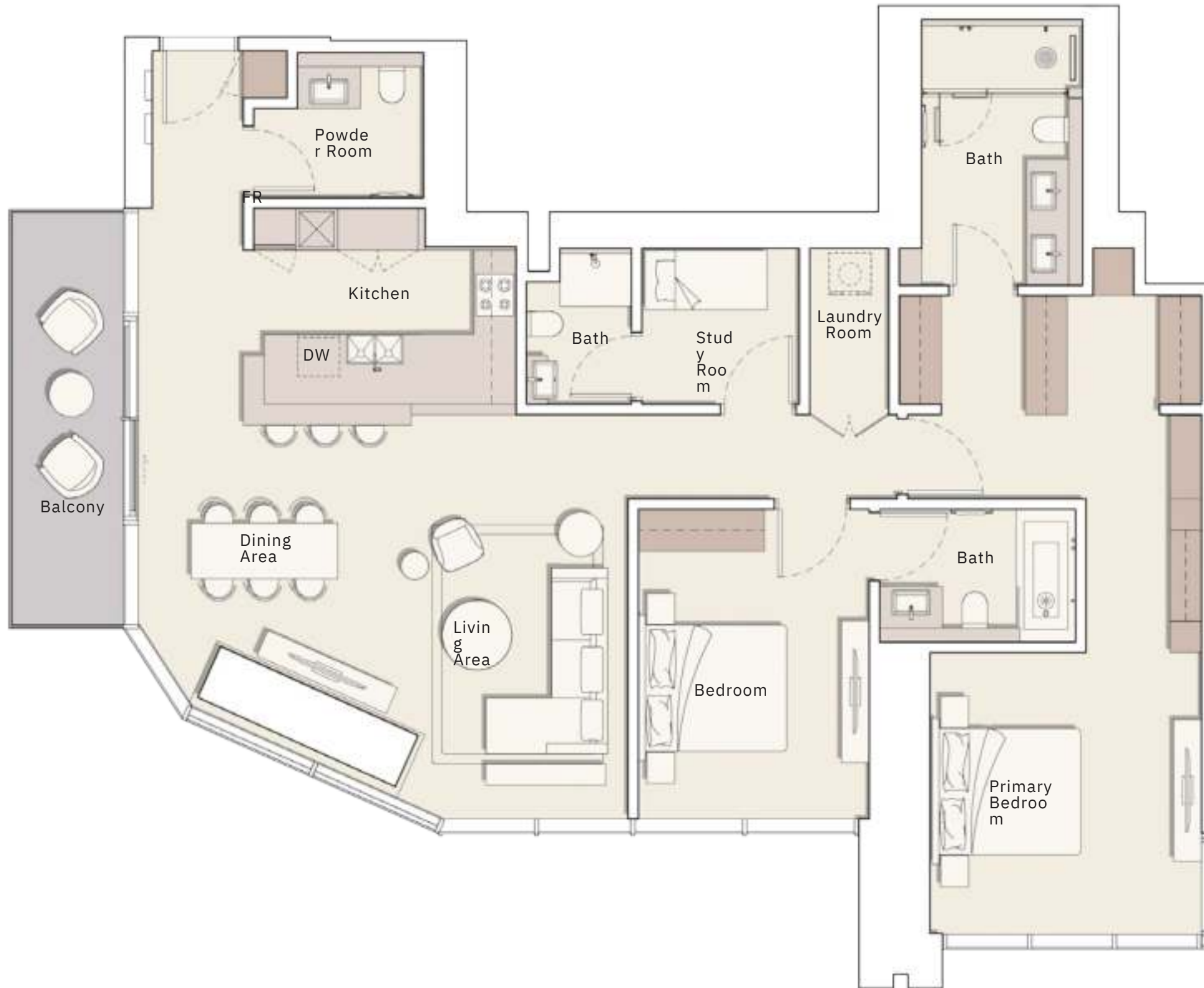

18th - 36th FLOOR

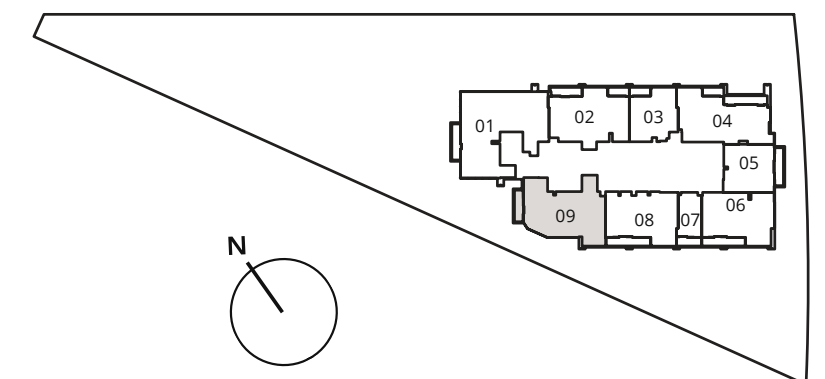

3 B E D R O O M

T Y P E A

Internal Living Area : **2276.24 Sq. Ft**
Outdoor Living Area : **121.09 Sq. Ft**
Total Living Area : **2397.34 Sq. Ft**



8th - 16th FLOOR
801

18th - 36th FLOOR
1801

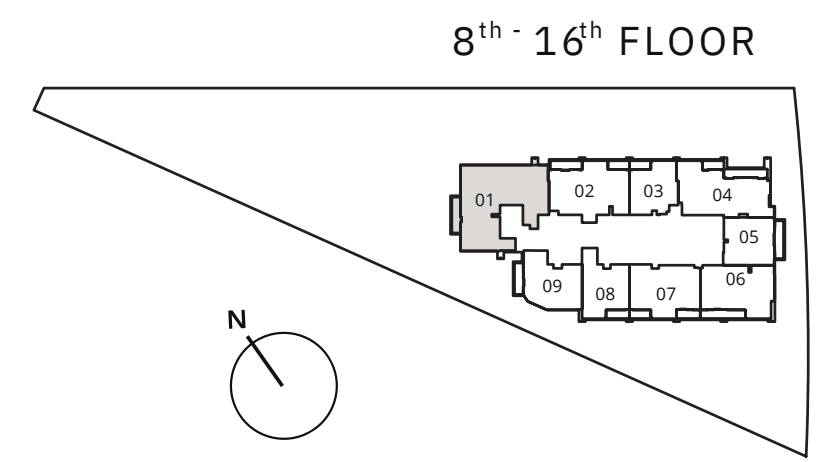

P R E M I U M

A P A R T M E N T S

3 BEDROOM DUPLEX

TYPE A

Internal Living Area : **3007.22 Sq. Ft**

Outdoor Living Area : **707.30 Sq. Ft**

Total Living Area : **3714.52 Sq. Ft**

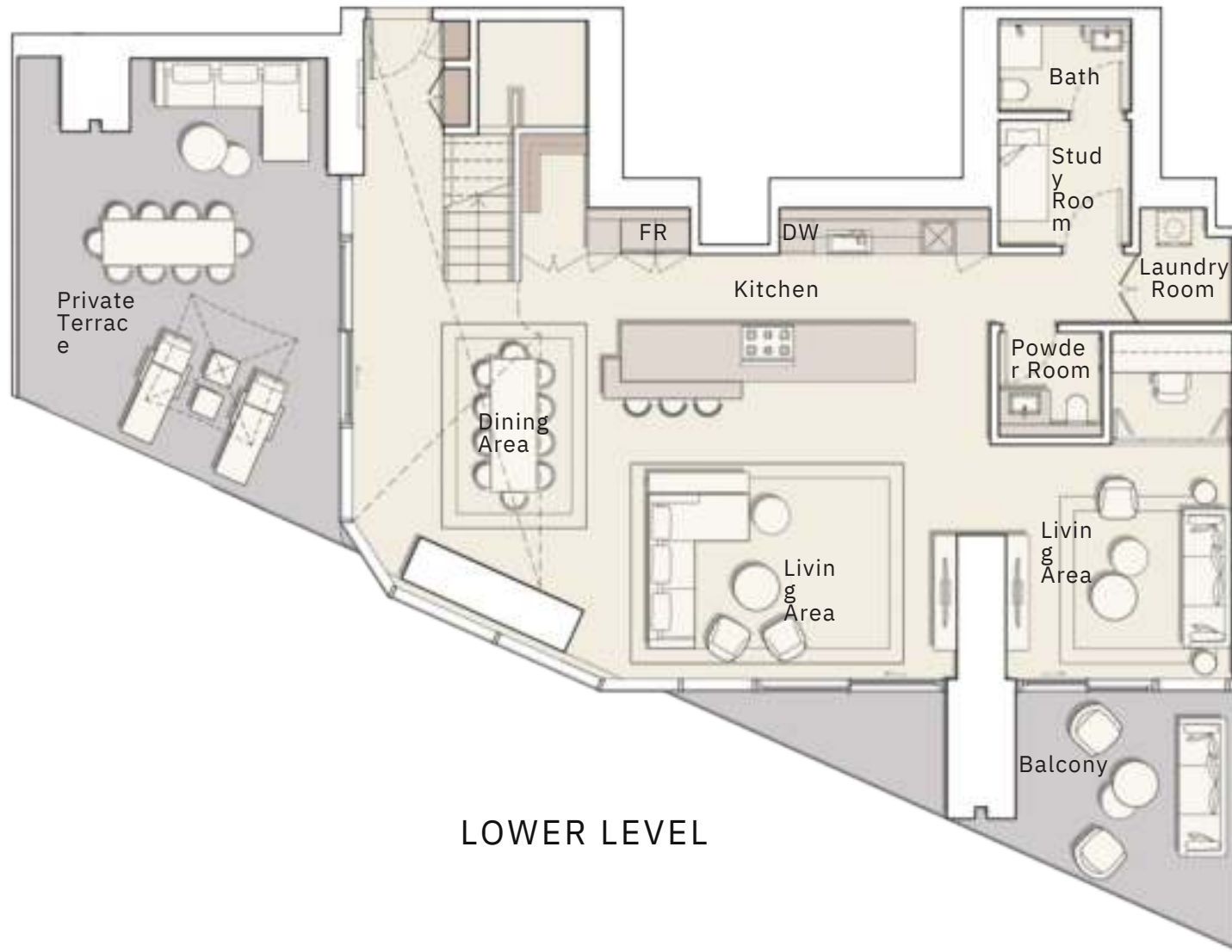

LOWER LEVEL

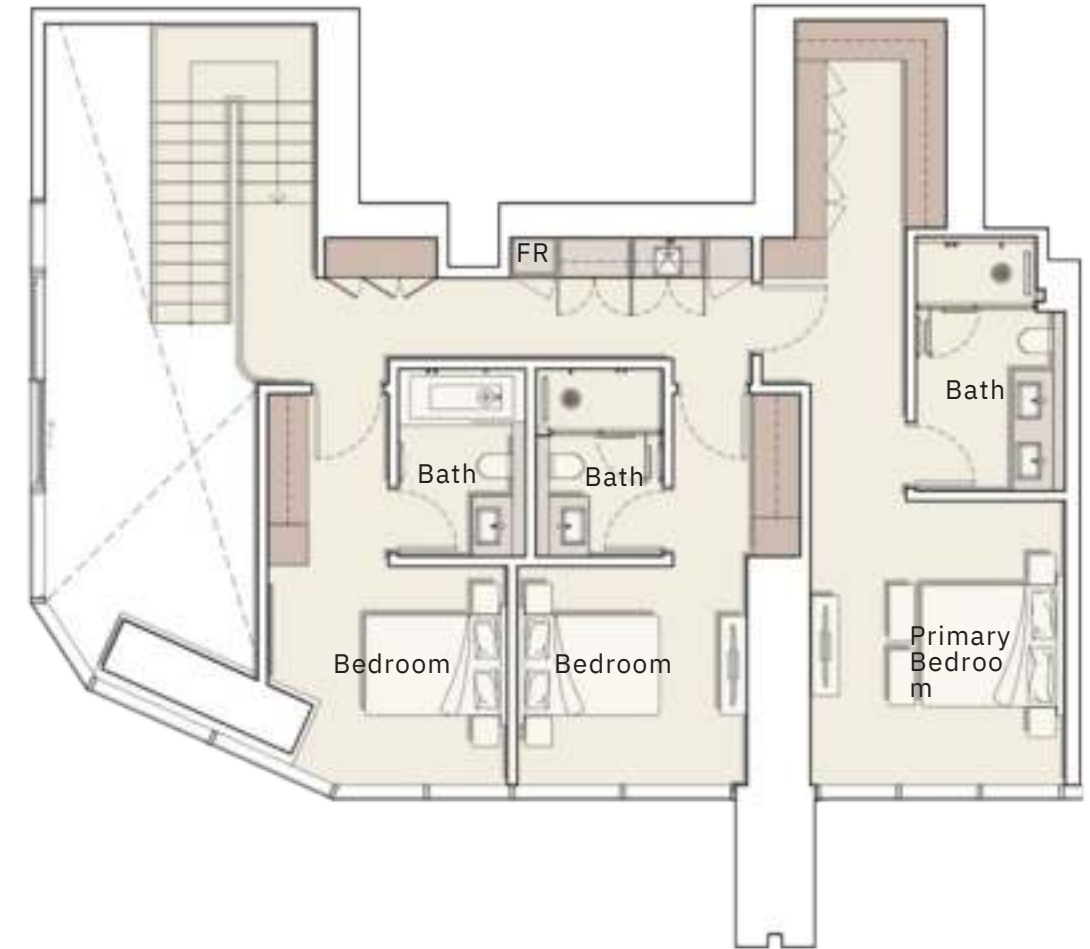

UPPER LEVEL

1st FLOOR

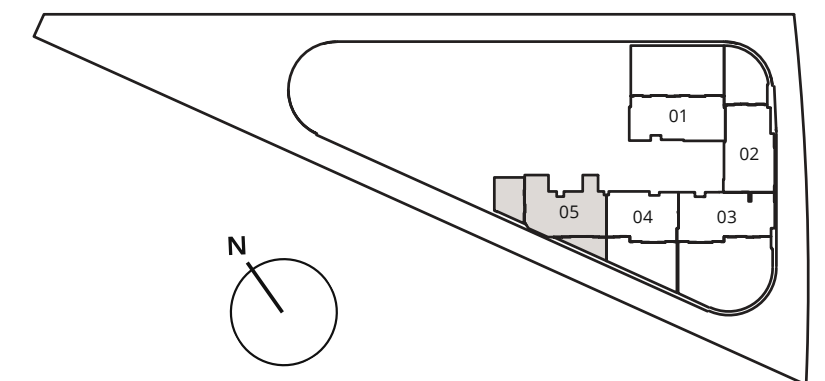

3 BEDROOM DUPLEX

TYPE B

Internal Living Area : **2468.49 Sq. Ft**

Outdoor Living Area : **993.62 Sq. Ft**

Total Living Area : **3462.10 Sq. Ft**

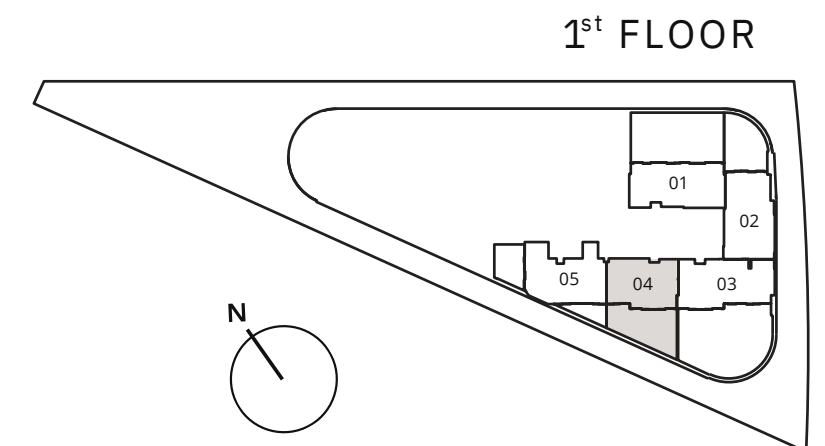
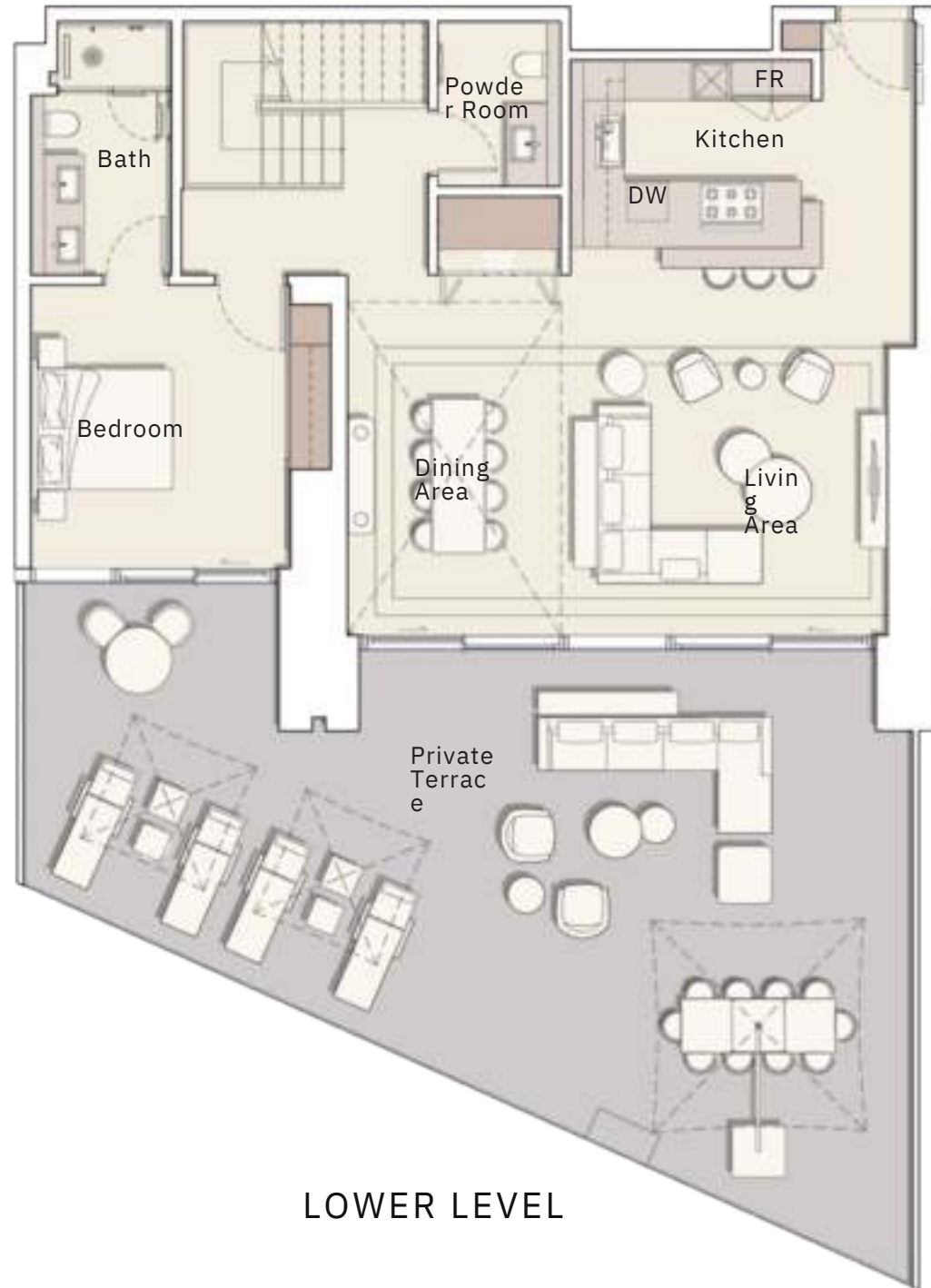

3 BEDROOM DUPLEX

TYPE C

Internal Living Area : **3125.73 Sq. Ft**

Outdoor Living Area : **842.92 Sq. Ft**

Total Living Area : **3968.65 Sq. Ft**

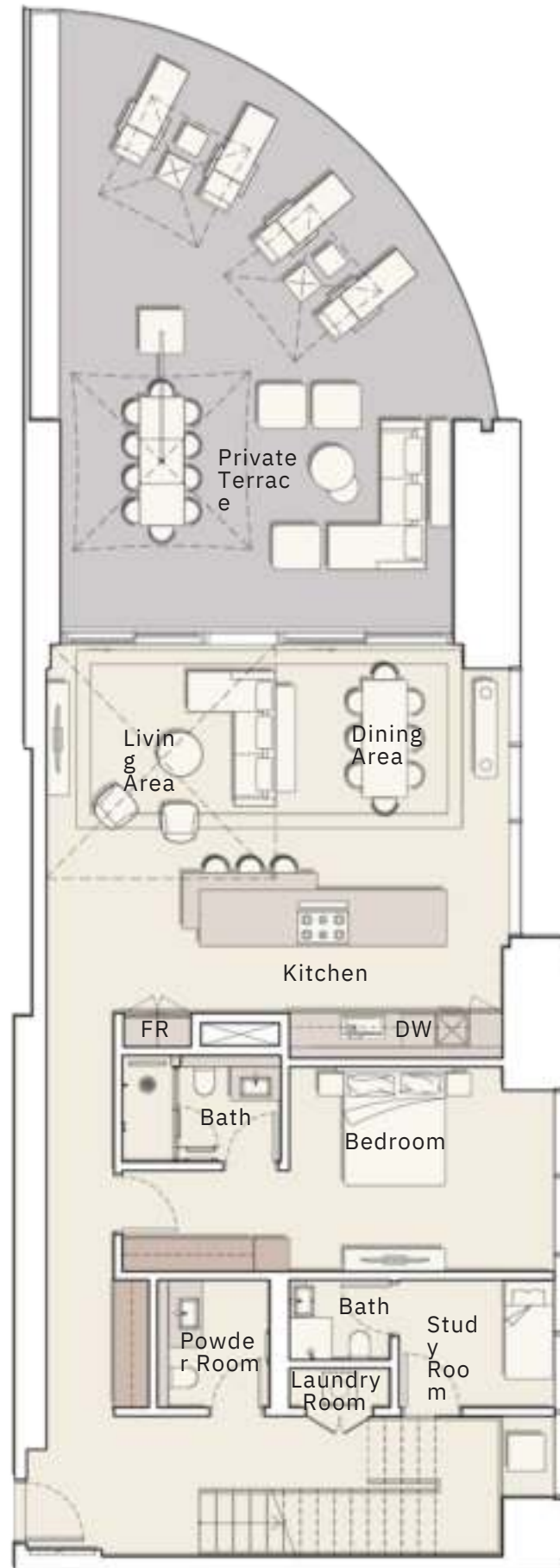

LOWER LEVEL



UPPER LEVEL

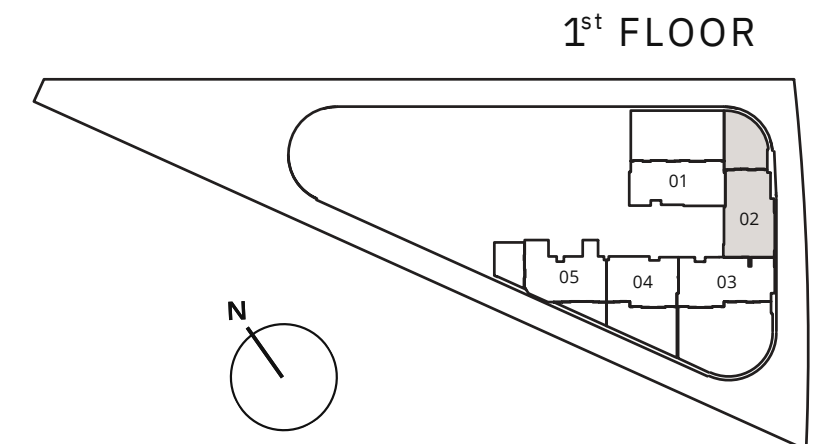

4 BEDROOM DUPLEX

TYPE A

Internal Living Area : **3128.96 Sq.**
Outdoor Living Area : **Ft 1842.89**
Total Living Area : **Sq. Ft**
4971.85 Sq.
Ft

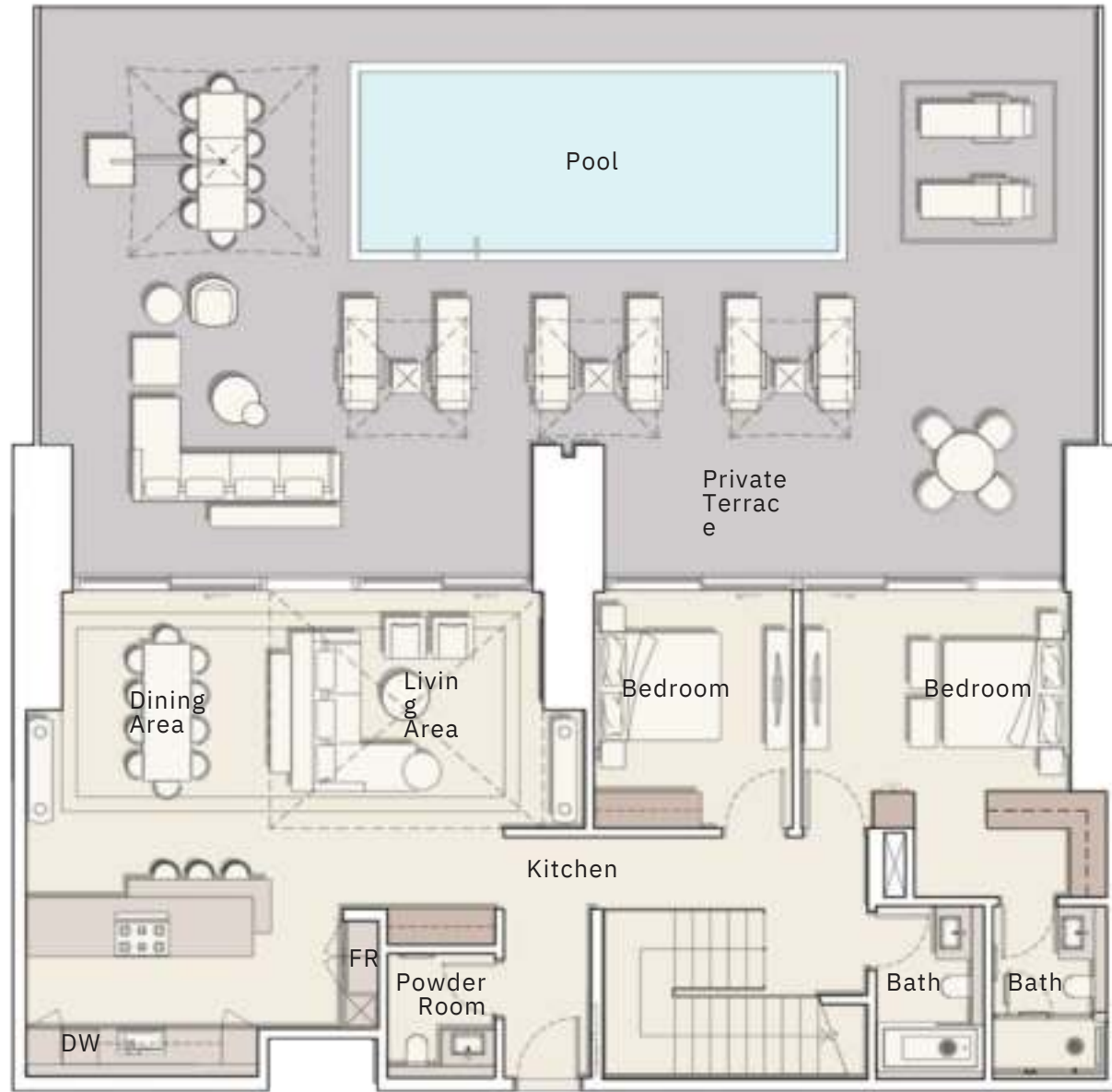

LOWER LEVEL



UPPER LEVEL

1st FLOOR

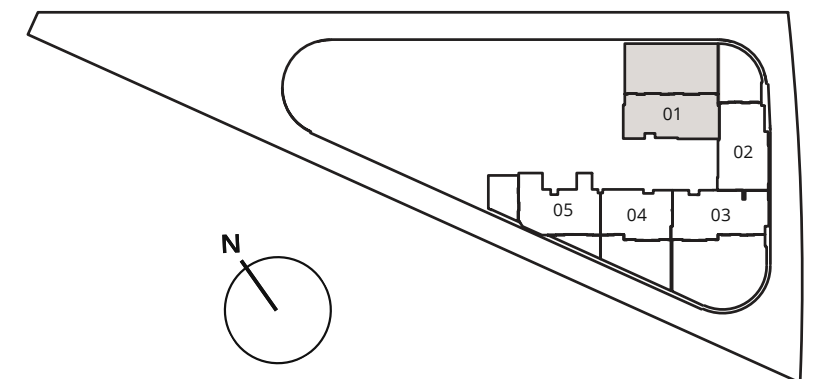

4 BEDROOM DUPLEX

TYPE B

Internal Living Area : **3246.50 Sq.**
Outdoor Living Area : **Ft 2329.74**
Total Living Area : **Sq. Ft**
5576.24 Sq.
Ft

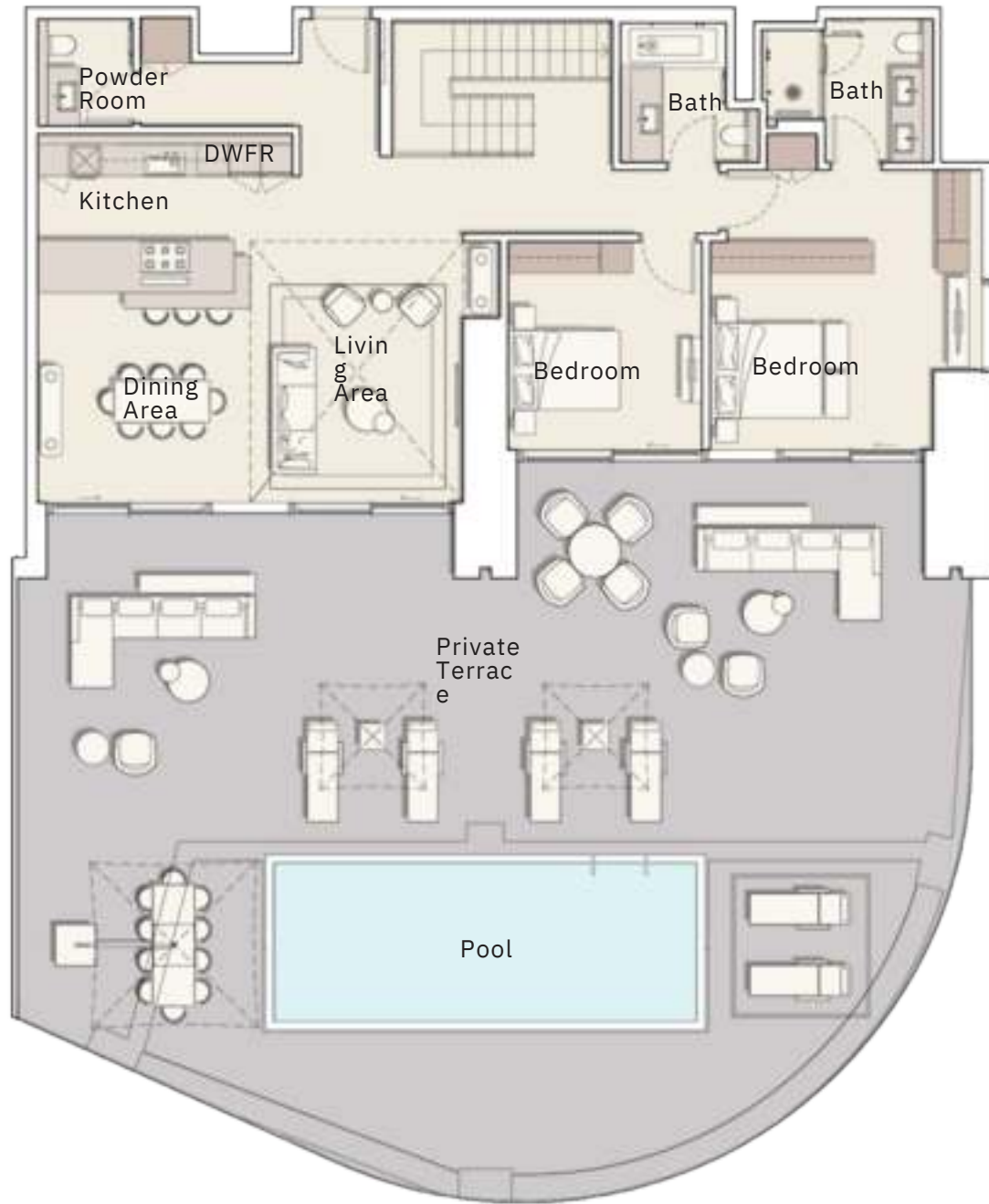

LOWER LEVEL



UPPER LEVEL

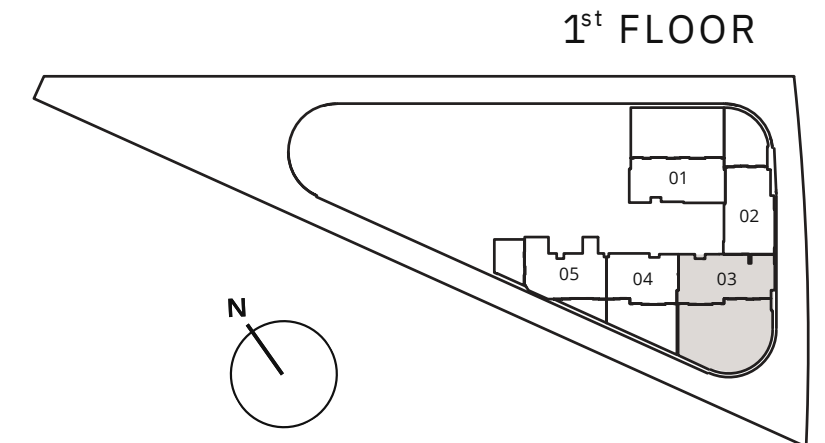

1st FLOOR

PENTHOUSE

TYPE A

Internal Living Area : **3398.92 Sq.**
Outdoor Living Area : **Ft 2448.57**
Total Living Area : **Sq. Ft**
5847.49 Sq.
Ft

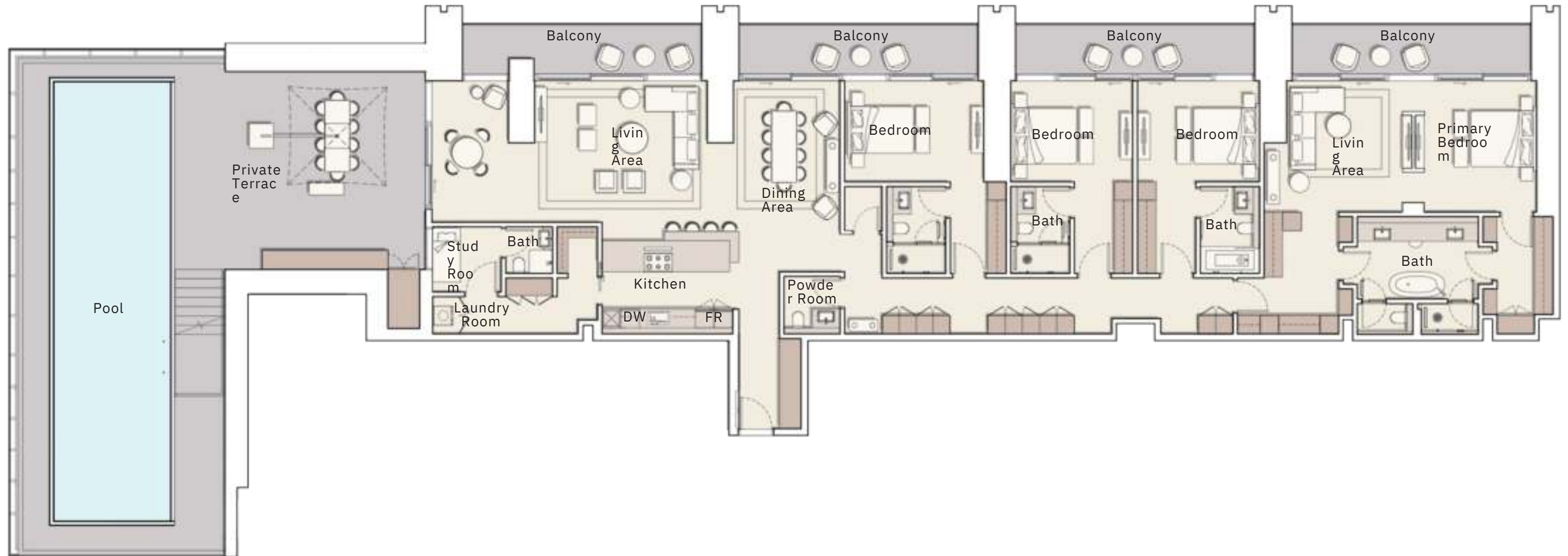

37th FLOOR

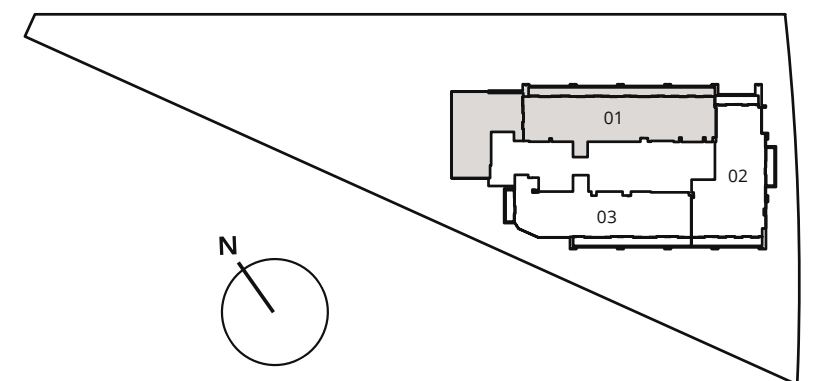

PENTHOUSE

TYPE B

Internal Living Area : **3221.42 Sq. Ft**

Outdoor Living Area : **513.22 Sq. Ft**

Total Living Area : **3734.65 Sq. Ft**

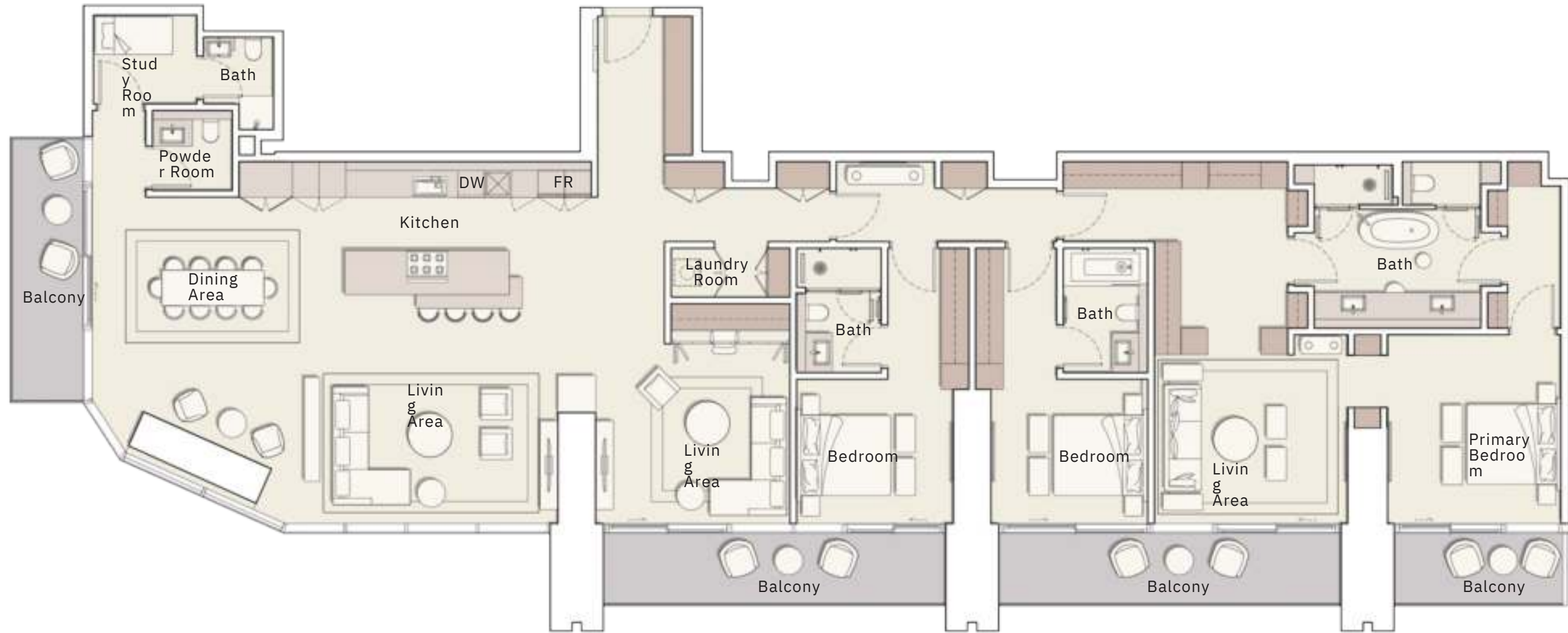

37th FLOOR

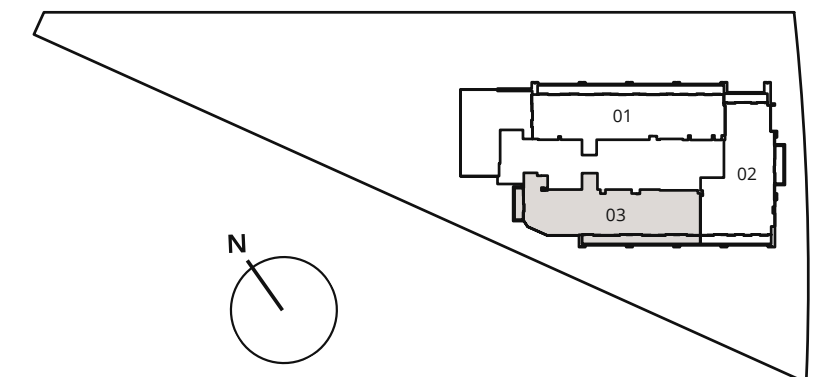

PENTHOUSE

TYPE C

Internal Living Area : **2980.96 Sq. Ft**

Outdoor Living Area : **521.83 Sq. Ft**

Total Living Area : **3502.79 Sq. Ft**

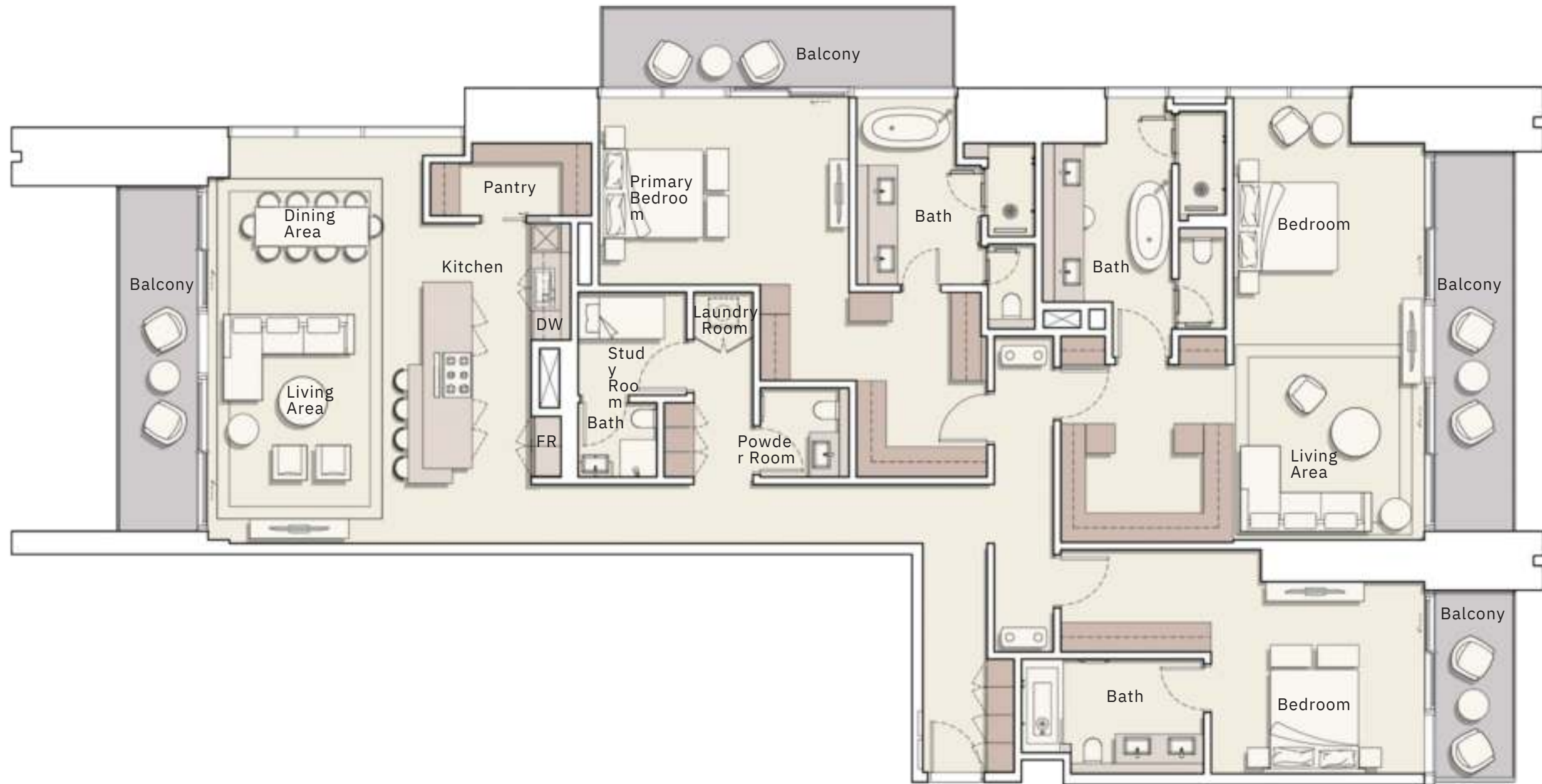

37th FLOOR

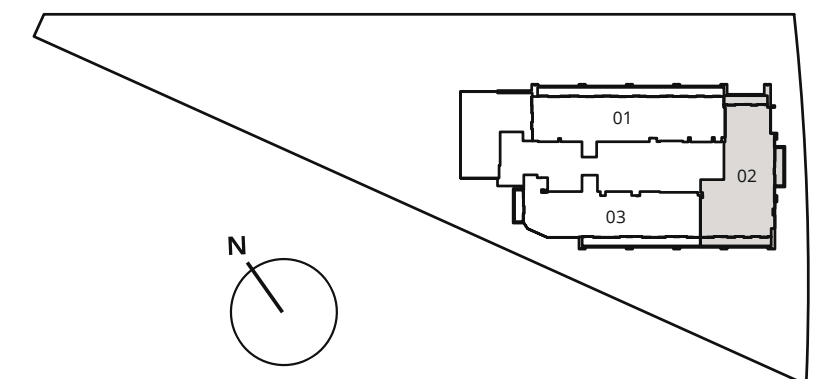



TOTALLY HOME

REAL ESTATE



[totallyhomerealestate](#)



[totallyhomerealestate](#)



[totallyhomerealestate](#)



[totallyhomerealestate.com](#)

 +971 54 289 7686

 sales@totallyhomerealestate.com

 support@totallyhomerealestate.com

 admin@totallyhomerealestate.com

 Office 103, Building 6 Bay Square Tower, Business Bay PO Box 418317, Dubai